

# zehnder bank-radiator

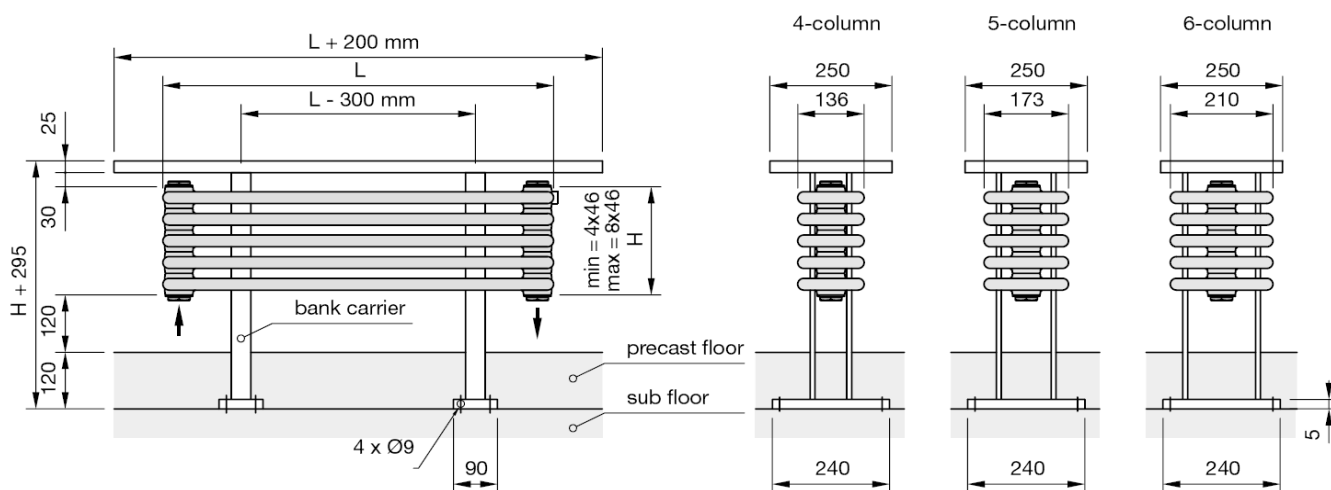

Модель	Размеры				Вес, кг	Теплоотдача, Watt		Цена в Евро 01,04,07		
	Высота скамьи, мм	Высота, мм	Длина, мм	Глубина, мм		Δt 50	Δt 60	Белый	Цвет	Металлик
B4120/4	479	184	1200	136	15,00	766	957	603	694	784
B5120/4	479	184	1200	173	18,84	921	1150	647	744	841
B6120/4	479	184	1200	210	22,48	1092	1364	682	785	887
B4150/4	479	184	1500	136	18,60	922	1151	678	780	882
B5150/4	479	184	1500	173	23,32	1130	1411	737	847	958
B6150/4	479	184	1500	210	27,88	1342	1676	792	911	1 030
B4180/4	479	184	1800	136	22,20	1108	1384	741	852	964
B5180/4	479	184	1800	173	27,84	1357	1695	805	926	1 047
B6180/4	479	184	1800	210	33,28	1612	2013	870	1 000	1 131
B4200/4	479	184	2000	136	24,60	1226	1531	789	908	1 026
B5200/4	479	184	2000	173	30,84	1516	1893	860	989	1 118
B6200/4	479	184	2000	210	36,88	1790	2235	931	1 070	1 210
B4250/4	479	184	2500	136	30,60	1555	1942	979	1 126	1 273
B5250/4	479	184	2500	173	38,32	1936	2418	1 066	1 226	1 386
B6250/4	479	184	2500	210	45,88	2307	2881	1 157	1 331	1 504
B4300/4	479	184	3000	136	36,60	1925	2404	1 096	1 260	1 425
B5300/4	479	184	3000	173	45,84	2403	3001	1 192	1 370	1 549
B6300/4	479	184	3000	210	54,88	2848	3557	1 304	1 499	1 695
B4120/5	525	230	1200	136	18,75	930	1161	665	765	865
B5120/5	525	230	1200	173	23,55	1119	1397	720	827	935
B6120/5	525	230	1200	210	28,10	1313	1640	764	879	994
B4150/5	525	230	1500	136	23,25	1107	1382	755	869	982
B5150/5	525	230	1500	173	29,15	1358	1696	828	952	1 077
B6150/5	525	230	1500	210	34,85	1600	1998	898	1 032	1 167
B4180/5	525	230	1800	136	27,75	1332	1663	830	954	1 079
B5180/5	525	230	1800	173	34,80	1626	2031	910	1 046	1 183
B6180/5	525	230	1800	210	41,60	1924	2403	990	1 139	1 287
B4200/5	525	230	2000	136	30,75	1439	1797	886	1 019	1 152
B5200/5	525	230	2000	173	38,55	1782	2225	974	1 121	1 267
B6200/5	525	230	2000	210	46,10	2121	2649	1 063	1 222	1 382
B4250/5	525	230	2500	136	38,25	1864	2328	1 095	1 260	1 424
B5250/5	525	230	2500	173	47,90	2323	2901	1 204	1 384	1 565
B6250/5	525	230	2500	210	57,35	2740	3422	1 318	1 516	1 713
B4300/5	525	230	3000	136	45,75	2312	2887	1 234	1 419	1 604
B5300/5	525	230	3000	173	57,30	2888	3607	1 354	1 557	1 760
B6300/5	525	230	3000	210	68,60	3388	4231	1 494	1 718	1 942
B4120/6	571	276	1200	136	22,50	1112	1389	727	837	946
B5120/6	571	276	1200	173	28,26	1289	1610	793	912	1 030
B6120/6	571	276	1200	210	33,72	1531	1912	846	973	1 100

Модель	Размеры				Вес, кг	Теплоотдача, Watt		Цена в Евро 01,04,07		
	Высота скамьи, мм	Высота, мм	Длина, мм	Глубина, мм		Δt 50	Δt 60	Белый	Цвет	Металлик
B4150/6	571	276	1500	136	27,90	1334	1666	833	957	1 082
B5150/6	571	276	1500	173	34,98	1577	1969	920	1 058	1 196
B6150/6	571	276	1500	210	41,82	1859	2322	1 004	1 154	1 305
B4180/6	571	276	1800	136	33,30	1560	1948	919	1 057	1 195
B5180/6	571	276	1800	173	41,76	1888	2358	1 014	1 167	1 319
B6180/6	571	276	1800	210	49,92	2236	2792	1 111	1 278	1 445
B4200/6	571	276	2000	136	36,90	1713	2139	983	1 131	1 278
B5200/6	571	276	2000	173	46,26	2104	2628	1 089	1 253	1 416
B6200/6	571	276	2000	210	55,32	2485	3103	1 195	1 375	1 554
B4250/6	571	276	2500	136	45,90	2185	2729	1 212	1 394	1 576
B5250/6	571	276	2500	173	57,48	2704	3377	1 342	1 543	1 744
B6250/6	571	276	2500	210	68,82	3189	3982	1 479	1 701	1 923
B4300/6	571	276	3000	136	54,90	2702	3374	1 372	1 577	1 783
B5300/6	571	276	3000	173	68,76	3352	4186	1 516	1 743	1 970
B6300/6	571	276	3000	210	82,32	3948	4930	1 684	1 936	2 189
B4120/7	617	322	1200	136	26,25	1179	1472	790	908	1 027
B5120/7	617	322	1200	173	32,97	1479	1847	866	996	1 125
B6120/7	617	322	1200	210	39,34	1735	2167	928	1 068	1 207
B4150/7	617	322	1500	136	32,55	1500	1873	910	1 046	1 183
B5150/7	617	322	1500	173	40,81	1825	2279	1 012	1 163	1 315
B6150/7	617	322	1500	210	48,79	2142	2675	1 109	1 276	1 442
B4180/7	617	322	1800	136	38,85	1790	2235	1 008	1 159	1 310
B5180/7	617	322	1800	173	48,72	2194	2740	1 119	1 287	1 455
B6180/7	617	322	1800	210	58,24	2567	3206	1 232	1 417	1 602
B4200/7	617	322	2000	136	43,05	1982	2475	1 080	1 242	1 404
B5200/7	617	322	2000	173	53,97	2444	3050	1 204	1 385	1 565
B6200/7	617	322	2000	210	64,54	2853	3563	1 328	1 527	1 726
B4250/7	617	322	2500	136	53,55	2519	3146	1 328	1 528	1 727
B5250/7	617	322	2500	173	67,06	3130	3909	1 480	1 702	1 924
B6250/7	617	322	2500	210	80,29	3677	4592	1 640	1 886	2 132
B4300/7	617	322	3000	136	64,05	3116	3891	1 509	1 736	1 962
B5300/7	617	322	3000	173	80,22	3881	4847	1 678	1 929	2 181
B6300/7	617	322	3000	210	96,04	4537	5666	1 873	2 154	2 436
B4120/8	663	368	1200	136	30,00	1382	1726	852	979	1 107
B5120/8	663	368	1200	173	37,68	1662	2076	939	1 079	1 220
B6120/8	663	368	1200	210	44,96	1941	2424	1 010	1 162	1 313
B4150/8	663	368	1500	136	37,20	1671	2087	987	1 135	1 283
B5150/8	663	368	1500	173	46,64	2050	2560	1 103	1 269	1 434
B6150/8	663	368	1500	210	55,76	2397	2993	1 215	1 397	1 579
B4180/8	663	368	1800	136	44,40	2011	2511	1 096	1 261	1 425
B5180/8	663	368	1800	173	55,68	2445	3053	1 224	1 407	1 591
B6180/8	663	368	1800	210	66,56	2812	3512	1 353	1 556	1 759
B4200/8	663	368	2000	136	49,20	2219	2771	1 177	1 354	1 530
B5200/8	663	368	2000	173	61,68	2736	3417	1 318	1 516	1 714
B6200/8	663	368	2000	210	73,76	3180	3971	1 460	1 679	1 898
B4250/8	663	368	2500	136	61,20	2821	3523	1 445	1 661	1 878
B5250/8	663	368	2500	173	76,64	3506	4378	1 618	1 860	2 103
B6250/8	663	368	2500	210	91,76	4120	5145	1 800	2 071	2 341
B4300/8	663	368	3000	136	73,20	3478	4343	1 647	1 894	2 141
B5300/8	663	368	3000	173	91,68	4368	5455	1 839	2 115	2 391
B6300/8	663	368	3000	210	109,76	5068	6329	2 063	2 373	2 682

Виды подключений

Цена в Евро

Виды подключений

Цена в Евро

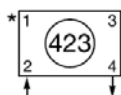
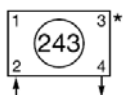

0,00

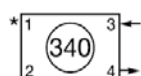
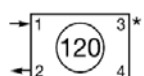

0,00

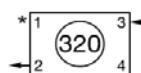
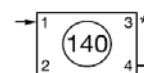

0,00

# Bankoberflächen neu: WERZALIT®

**zehnder** *bank-radiator*

**zehnder** *bank-radiavektor*

**zehnder** *ablage-radiavektor*



445 Hainbuche



131 Quarz



112 Puntinella

Длина прибора L мм
1 000
1 200
1 400
1 600
1 800
2 000
2 200
2 400
2 600
2 800
3 000

Длина доски мм
1 260
1 460
1 660
1 860
2 060
2 260
2 460
2 660
2 860
3 060
3 260

Цена в Евро 01,04,07
427
459
491
523
555
603
635
667
718
731
771